

# M323F

## RAILROAD HYDRAULIC EXCAVATOR



**Engine Power**  
**Operating Weight**

127 kW (170 hp)  
22 900 kg (50,500 lb)

Cat® C4.4 ACERT™ Engine meets U.S. EPA Tier 5 Final and EU Stage V emission standards with an aftertreatment system that requires no operator input or downtime.



THE NEXT GENERATION RAILROAD EXCAVATORS, ALREADY UPGRADED

As being compliant with the EN15746 is not enough, CAT is pleased to present the augmented version of its 9A rail drive machine. And always the same goal brought to you:

- + MORE SAFETY
- + MORE EVOLVED TECHNOLOGIES
- + MORE PRECISION AND VERSATILITY

**TRACK THE LOGO,  
YOU WILL SEE HOW  
AUGMENTED THE M323F IS**

Ready to help you make your business stronger and safer, Cat RailRoad Excavators give you new ways to get the most work done at the lowest cost.



# THE SWISS KNIFE

# CAT<sup>®</sup> M323F

## MOVING THE STANDARD ON RAILS

**9A CATEGORY RAIL DRIVE  
SHORT RADIUS < 1575 MM  
EU COMPLIANT - EN15746**

<b>UIC</b>		<b>TRAC GAUGE</b>
<b>METRIC</b>		
<b>BROAD</b>		



## INCREASED LIFTING CAPACITIES UP TO 30%

THE BEST IN ITS CATEGORY

### STANDARD, SIMPLE-TO-USE TECHNOLOGIES INCLUDE:

#### STANDARD CAT SMART CONTROL SYSTEM

The CAT M323F is equipped with the most evolved system to control all motions while in rail mode: the SMART CONTROL SYSTEM. This feature automatically slows down and stops excavator motion using boundaries. To set and follow rotation and height limitation parameters, the operator uses a very simple, smart and intuitive controller with 12" HD color screen. Once limitations are set, the operator is free-minded to focus on his tasks, knowing that front linkage and tool will never be in contact with the overhead lines or get out of the defined work envelope.

#### STANDARD CAT RCI/RCL

The machine is fitted with RCI and RCL systems that enable the operator to work safely during lifting operations. A series of sensors calculates in real time the exact position of the machine :

- The slope and lateral slope of the machine,
- The orientation of the upper frame,
- The full geometry of the front linkage, from stub boom to bucket.

The RCI/RCL system defines the maximum authorized load at tool point and auxiliary lifting point (ALP). Its purposes are :

- Warning and informing the operator, with sound and visual signals, of the load applied and the rated load at lifting points.
- Limiting and controlling the front linkage and swing movements.

When the rated lifting load is reached, the RCL system blocks any motion that might affect the stability of the machine, including backward stability (backward tipover hazard in curves and on rails with cant) and anti-derailment (minimal wheel load to ensure contact with rail), and only allows any motion that secures the position of the machine.

#### STANDARD AUTOMATIC OSCILLATING AXLE LOCK

In Working Mode, machine automatically locks the rail oscillating axles. When locked, this ensures full stability in digging phases and increases lifting capacities. When Traveling Mode is set on, SMART CONTROL SYSTEM unlocks the oscillating axles. This allows the machine to travel on rails, drive at full speed on twisted and poor condition tracks with cant up to 200 mm and inside curves.

#### STANDARD RAIL SPECIFIC FEATURES

Along with the Smart Control System, machine is fitted with additional and rail specific features :

- One-way or two-way travel pedal with dedicated controls and new advanced joysticks in cab.
- Temporary Limits Off feature: This key-activated feature disables the active limitations (height or swing limits) during a limited time without compromising the stability of the machine.
- Smart Control System key-lock feature allows the worksite safety manager to lock the defined boundaries
- Stop Convoy feature that allows any personnel on work site along the track to stop machine from traveling when equipped with rail trailers. Feature activation by key is under operator responsibility and obey to local railway regulations in force.
- Additional heavy counterweight detection: When detected, Smart Control System adapts lifting capabilities accordingly.

# CAT SMART CONTROL SYSTEM

TAKES THE SAFETY FIRST OUT OF MANAGING YOUR EQUIPMENT

Rail-specific CAT SMART CONTROL SYSTEM allows setting limits to the machine movements and provides real-time implement kinematic/machine rotation position. Movements slow down smoothly when approaching the preset limits. Moves beyond these limits are blocked.

## Rail Gauge Detection system

When active, this feature automatically detects if the machine is equipped with UIC (1435 mm) or metric (1000 mm) rail axles and adapts automatically the RCI/RCL system to the rail track for full safety during lifting operations.



## Instrument Panel

This dashboard gathers information and signals such as:

- One-way travel pedal signals
- Heavy duty counterweight detection
- Stop Convoy activation signal
- Display for UIC or rail trailer brake pressure
- Display for hydrostatic deceleration power and air tank pressure
- Key lock for Smart Control System parameters
- Temporary Limits Off feature with key activation



## Side and Rear Cameras

The CAT SMART CONTROL SYSTEM screen also provides a clear view around the machine, on the rear and on the right side thanks to ideally located night vision cameras.

A full screen view is available for a setup time (up to 300 s) by a simple touch on the chosen camera, side view or rear view.



## Tool Definition

To ensure a full control until the last millimeters, the CAT SMART CONTROL SYSTEM permits to set the dimensions of your tools from bucket to oversized rail dedicated tooling.

Once set up, the tool is fully part of the front linkage and obey to boundaries limits.

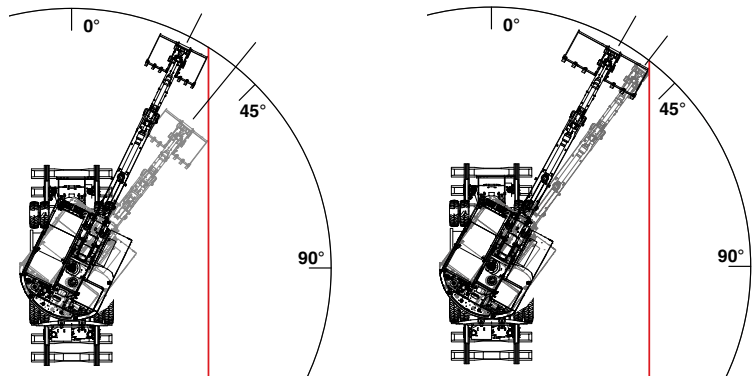
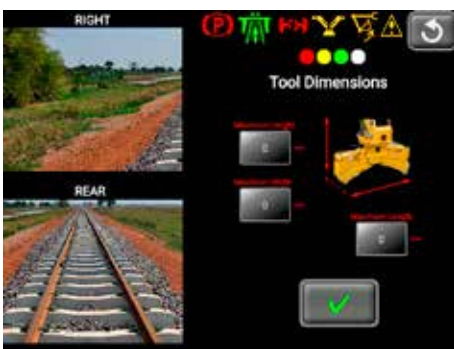

# CAT LINK TECHNOLOGY

TAKES THE GUESSWORK OUT OF MANAGING YOUR EQUIPMENT

---

**CAT LINK** telematics technology helps take the complexity out of managing your jobsites – by gathering data generated by your equipment, materials, and people and serving it up to you in customizable formats.



## **PRODUCT LINK™**

Product Link™ collects data automatically and accurately from your assets – any type and any brand. Information such as location, hours, fuel usage, productivity, idle time, maintenance alerts, diagnostic codes, and machine health can be viewed online through web and mobile applications.



## **VISIONLINK®**

Access information anytime, anywhere with VisionLink® – and use it to make informed decisions that boost productivity, lower costs, simplify maintenance, and improve safety and security on your jobsite. With different subscription level options, your Cat dealer can help you configure exactly what you need to connect your fleet and manage your business without paying for extras you don't want. Subscriptions are available with cellular or satellite reporting (or both).



**Remote Services** is a suite of technologies that improve your jobsite efficiency.

**Remote Troubleshoot** allows your Cat dealer to perform diagnostic testing on your connected machine remotely, pinpointing potential issues while the machine is in operation. Remote Troubleshoot ensures the technician arrives with the correct parts and tools the first time, eliminating additional trips to save you time and money.

**Remote Flash** updates on-board software without a technician being present, potentially reducing update time by as much as 50%. You can initiate the update when convenient, increasing your overall operating efficiency.

The **Cat App** helps you manage your assets – at any time – right from your smartphone. You can see your fleet location, hours, and other information you need to see. You will get critical alerts for required maintenance, and you can even request service from your local Cat dealer.

# TOWING FEATURES

READY FOR UIC-TYPE WAGON OR RAIL TRAILERS



**MORE FLEXIBILITY**  
**MORE WON**  
**TENDERS**

As an option, machine is equipped with pneumatic and electric features to allow towing of UIC-type wagons or rail trailers. Strong towing capacities allow up to 220 t with 8 wagon axles. Machine and wagon are easily and safely coupled using a certified tow bar and an automatic coupling system. New air pressure strategy allows saving time and keeps downtime to a minimum when convoy is brought to a stop. Time gain is about 60% when keeping pressure to 3 bar in tank.

Be competitive by saving costs. Get rid of third part companies to support your working site or additional machines and personnel. As the machine is autonomous on tracks, take your raw material and your tools up to the work area on your own. Along with towing features, undercarriage offers now up to 50 A power supply to handle next generation of smart rail trailers that will come with equipment requiring power.

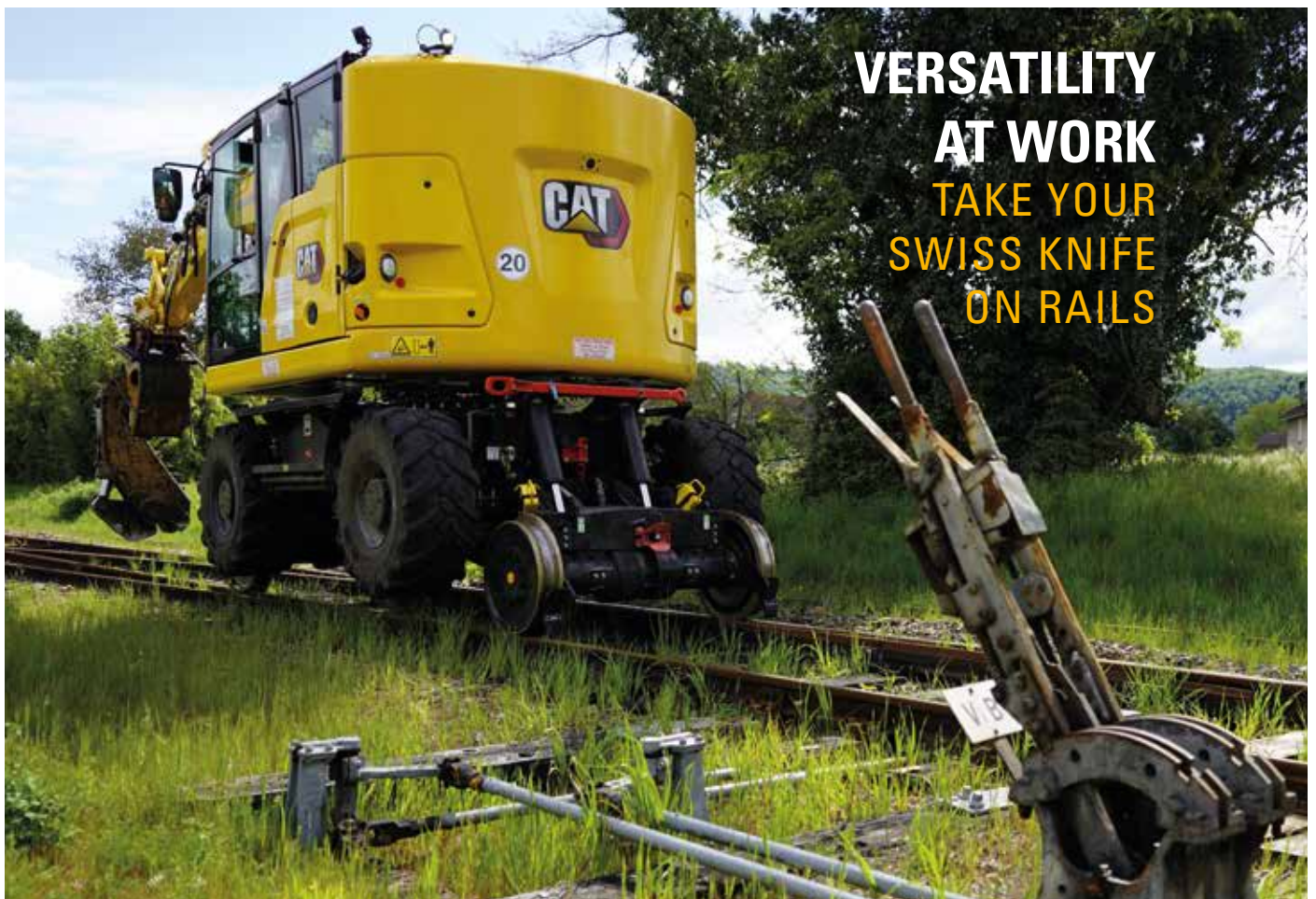

**VERSATILITY**  
**AT WORK**  
**TAKE YOUR**  
**SWISS KNIFE**  
**ON RAILS**

# SAFETY FEATURES

## LOOK OUT FOR YOUR PEOPLE AND YOUR EQUIPMENT



Daily maintenance checks can be performed with 100% of the points accessible from ground level, making maintenance faster, easier, and safer. Standard LED lights give you a better view of your jobsite.

++ Enjoy better visibility into trenches, in each swing direction, and behind you. The smaller cab pillars, larger windows, and a flat engine hood design lower obstruction to your view. Rearview and sideview cameras are standard.

++ The standard sound suppression ROPS cab meets ISO 12117-2:2008 requirements and helps to block the noise to stay focused on the job.

++ The service platform design provides easy, safe, and quick access to upper platform through the second cab. The steps use anti-skid punch plate to prevent slipping. The retractable step provides better clearance to ground during on-/off-tracking phase.

++ The auto axle lock presses the pedal for you to reduce your overall number of actions. The machine automatically detects when the service brake and axle need to be locked or unlocked. It releases automatically when you set the traveling mode and press the travel pedal.



### STAY SAFE EVERY DAY

#### FACT:

#1 cause of construction accidents: **FALLS\***

#### FALLS

**49%** OF FALLS RESULT IN SERIOUS INJURY

**30%** OF FALLS RESULT IN DEATH

#### M323F

**100%** GROUND-LEVEL MAINTENANCE  
HELP PREVENT FALLS



\*<https://www.ncbi.nlm.nih.gov/pmc/articles/PMC4962179/>

# UNDERCARRIAGE

STRENGTH AND VERSATILITY AT 20 KM/H (12.4 MPH)



## Heavy Duty Road Axles

Long life with effective heavy duty axles. The transmission is mounted directly on the rear axle for protection and optimum ground clearance. The front axle offers wide oscillating and steering angles. The advanced disc brake system minimizes the rocking effect when working free on wheels. The disc brake system acts directly on the hub instead of the drive shaft to avoid planetary gear backlash.

## Reliable and Proven Rail Axle System

The M323F comes out with the choice to run on three different track gauges: UIC (1435 mm), Metric (1000 mm) or Broad Gauge (1600 mm). Patented full hydrostatic rail axle system equipped with :

- Rail all-wheel drive
- Two-speed motor with adjustable hydrostatic deceleration.
- Dual-cylinder system to lower or raise the machine during on/off-tracking.
- Iron cast cradle with oscillating-suspension system for each rail axle.
- Integrated hydraulic drive on each axle with wet emerged discs for parking brake.
- Service brake disc on each wheel, protected from derailment by the rail wheel.
- Ø632 mm UIC rail wheels with insulated or non-insulated system, depending on local regulations.

While on tracks, operator uses the same controls and pedals than in road mode. First gear allows maximum torque of 45 kN and speed up to 10 km/h, ideal for towing UIC-type wagons or rail trailers. Second gear allows max speed of 20 km/h as set by railway regulations.

## Travel Restraint Bracket

The CAT M323F is equipped with a travel restraint bracket for clamshell/grapple tool. Thanks to this support, you can easily secure your tool's movement during road and rail traveling.



# BOOM AND STICK

HOW TO TAKE ON YOUR FAR-REACHING OR UP-CLOSE TASKS



## Customize Your Boom

Factory build with all hydraulic lines that could be required for your railway dedicated tools.

Standard auxiliary hydraulics, including high pressure and quick coupler lines and circuits, allow easy attachment changes without the need to add other lines to your machine. Need more? Second medium pressure line, second high pressure lines, 24 V socket on stick, drain return line, auxiliary line with fourth pedal are still available as options.

## Overpowered Machine

Upper frame offer up to 90 A available power. This allows you to install any additional equipment requiring power. All fuse boxes are ready with wired spare fuses.

## 3-Piece Boom Kinematic and Specific Stick

The combination of a variable adjustable boom and stick provides the right balance of reach and digging force in rail applications and operations. Three-piece front linkage with short stick for improved kinematics on rails. Stick is specifically designed for rail applications in order to maximize working range under rail track overhead lines and ease lifting operations in rail environment. Full reach at ground level up to 8 m with your bucket.

As lifting operations are a big part of the job, the M323F is equipped with an auxiliary lifting point (ALP) and lifting eye at powerlink with a safe working load (SWL) of 8 t as a standard.



## Be Seen and See on Working Area

Additional new LED working lights in option to get a clear view at 360° around your machine and on the working area, so you can keep a close eye on personnel on site, without blind spot. Up to 14 LED working lights can equip the machine for a quantity of 25,200 Lumens.

# OPERATOR & SECOND CAB

WHEN COMPACT RADIUS DOES NOT MEAN REDUCED CABS SIZE



## Second Cab for Railway Compliance

As dedicated to rail environment and compliant to EN15746, the M323F is equipped with a second cab to receive the railway safety attendant when traveling on rails. Second cab includes specific controls and commands such as 12V 10A power supply socket, emergency stop button and pneumatic horn switch. Cab is also ready to install all compulsory rail safety devices thanks to scratch bands and support, depending on local regulations.

## Plug and Charge

The 12V 10A power supply socket is conveniently located in operator and second cab for charging your laptop, a tablet or connect a radio on a railway working area. Second cab is also fitted with 24V 20A power socket, useful to plug an external refueling station for example and ease the refueling operation while machine is on rails.

## Bluetooth® / USB Radio

Bluetooth® integrated radio allows for seamless mobile phone connection to listen to music, podcasts and handsfree calling.

## Ergonomic Layout

Controls are positioned to reduce fatigue and straining movements to help keep you operating at your full potential. New ergonomic joysticks come as a standard too. Smart Control System display is mounted on a new adjustable support so you can reduce the glare effect when necessary.

## Smart Controls to Reduce Fatigue

New technologies that work transparently like the cruise control now available on rail too, swing and implement travel lock or the automatic oscillating axle lock on rail, reduce the number of tasks you need to do. You also have the choice between a one-way or two-way travel pedal at your convenience.

## Reduce Cab Vibrations

Feel more comfortable in the cab while you work with reduced cab vibrations from advanced viscous mounts.

## Comfortable Seat Options

Our seats provide all the comfort needed for a long day of work, including full adjustment. All seats are heated and air suspended, with automatic weight adjustment.

## Safety Is Not Optional

ROPS operator and second cab, seat belt alarm, safety bar, side and rear view cameras displayed on 12" HD screen and others. As engine failure is not an option on railtracks, the M323F is equipped with a backup electro-hydraulic pump. In case of emergency or main failure, press the dedicated switch to run the backup pump and use all main control commands, joysticks and pedals, to set the machine into travel position and take it to a safe area.



# DIMENSIONS

## OVERALL DIMENSIONS AND CLEARANCE

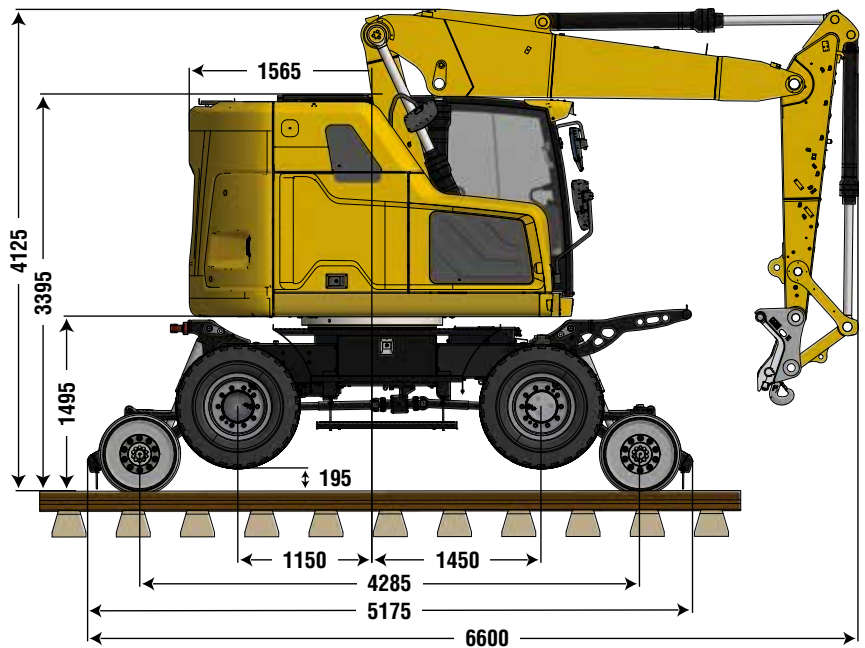
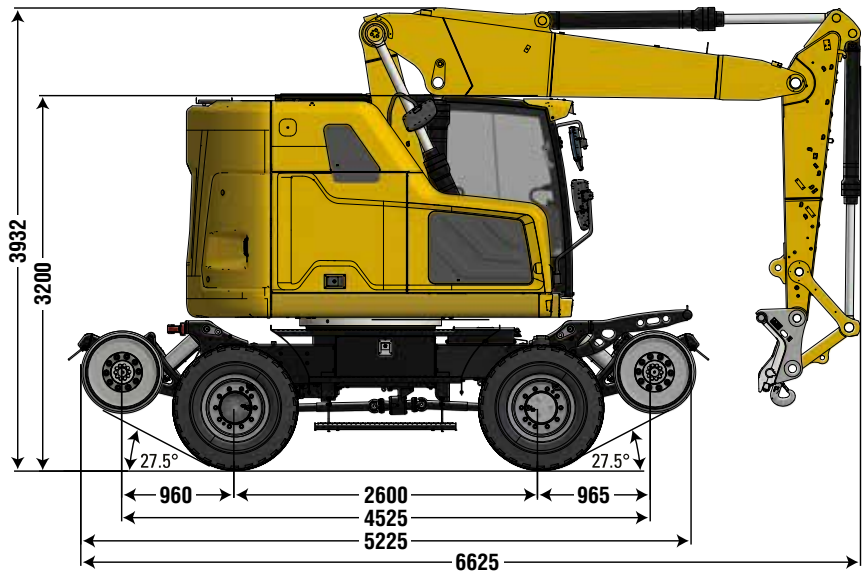

All dimensions are approximate and may vary depending on front linkage position or tires for ground clearance.

FRONT LINKAGE CONFIGURATION	
Standard 2-Piece Boom	Variable Adjustable
Standard Stick	2000 mm
TOP OF CAB HEIGHT	
Road Mode	3200 mm
Rail Mode	3395 mm
OTHER	
Tail Swing Radius	1565 mm

SHIPPING DIMENSIONS	
Length With Boom/Stick Installed	6600 mm
Upper Frame Width	2550 mm
Height With Boom/Stick Installed	3932 mm
COUNTERWEIGHT CLEARANCE	
Road Mode	1305 mm
Rail Mode	1495 mm

# ON RAILS CLEARANCES

## DIMENSIONS AND CLEARANCES IN WORKING AND TRAVELING MODE ON RAILS

Example of clearances while on rails under live overhead lines at 3920 mm and 4280 mm. Retractable hydraulic step improves ground clearance on rail tracks. Short radius design complies with railway-specific environments without compromising the excavators' performance and stability. New stick design optimizes working range under overhead lines.

WORK MODE - PARALLEL TO TRACK	
<b>Overhead Line Clearance</b>	<b>3920 mm</b>
1 Swing Center to Tool Point	7360 mm
2 Overall Height	3920 mm
3 Tool Point to Rail	3280 mm
<b>Overhead Line Clearance</b>	<b>4280 mm</b>
1 Swing Center to Tool Point	7080 mm
2 Overall Height	4280 mm
3 Tool Point to Rail	3503 mm
WORK MODE - SWING AT 90°	
<b>Overhead Line Clearance</b>	<b>3920 mm</b>
4 Overall Height	3920 mm
5 Tool Point to Rail	1280 mm
6 Swing Center to Tool Point	5400 mm
<b>Overhead Line Clearance</b>	<b>4280 mm</b>
4 Overall Height	4280 mm
5 Tool Point to Rail	1620 mm
6 Swing Center to Tool Point	5400 mm
TRAVELING MODE	
<b>Overhead Line Clearance</b>	<b>3920 mm</b>
7 Overall Height	3920 mm
8 Tool Point to Rail	1275 mm
9 Swing Center to Tool Point	5400 mm
<b>Overhead Line Clearance</b>	<b>4280 mm</b>
7 Overall Height	4280 mm
8 Tool Point to Rail	1620 mm
9 Swing Center to Tool Point	5400 mm
WORD MODE - SWING ROTATION	
10 Swing Center to Machine Front	1715 mm
11 Swing Center to Machine Front Corner	2130 mm

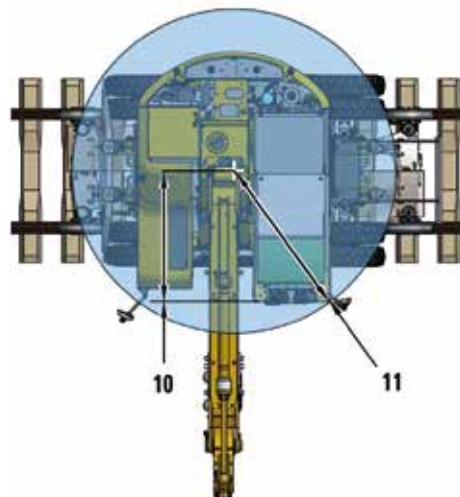
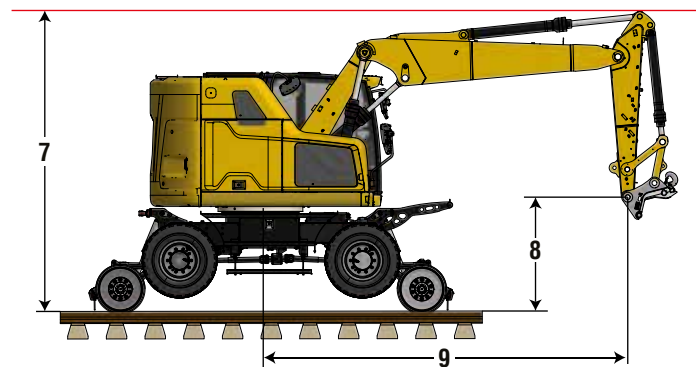
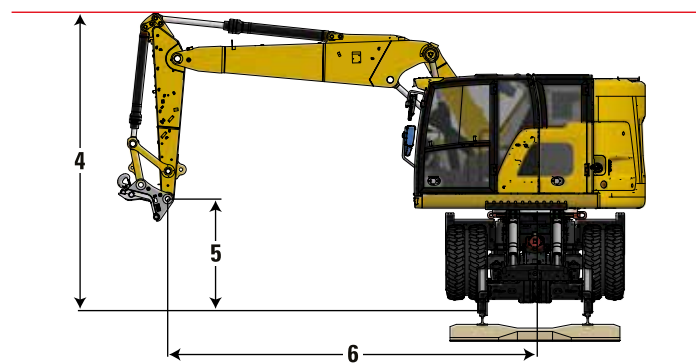
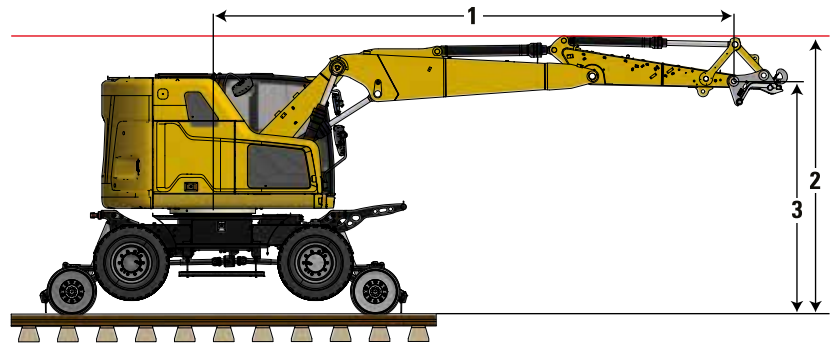

All dimensions are approximate and may vary depending on stick position.

# WORKING RANGES

AT TOOL POINT AND AUXILIARY LIFTING POINT

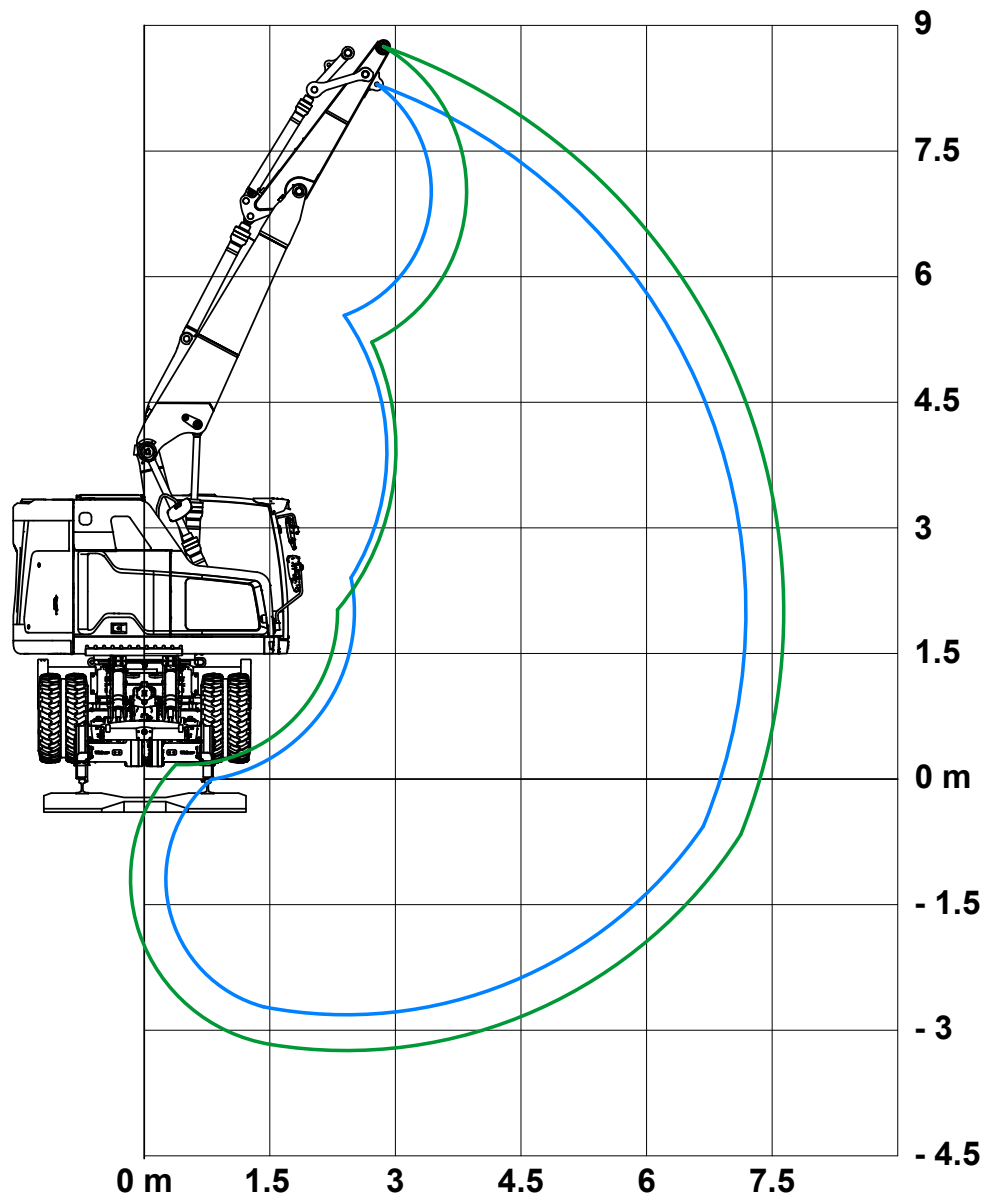

## RANGE VALUES

Variable Adjustable Boom	5200 mm
Stick Length	2000 mm
Digging Height*	10190 mm
Digging Depth*	4730 mm
Reach*	9100 mm
Reach at Ground Level*	8870 mm
Height at Toolpoint	8740 mm
Height at Auxiliary Lifting Point (ALP)	8290 mm
Reach at Toolpoint, at Ground Level	7350 mm
Reach at Auxiliary Lifting Point (ALP), at Ground Level	6880 mm
Bucket Digging Force (ISO 6015)*	160 kN
Stick Digging Force (ISO 6015)*	83 kN

\* : Range values are calculated with GD bucket 1100 mm, 0.80 m<sup>3</sup> with tips K080 and CW-20-H.4.N quick coupler with a tip radius of 1574 mm. Breakout force values are calculated with heavy lift on (no quick coupler) and a cutting edge tip radius of 1237 mm.

# LIFT CHARTS

## VARIABLE ADJUSTABLE BOOM, STICK 2000 MM

### ROAD MODE – COUNTERWEIGHT: 6.4 T

All values are in kg. ALP stands for Auxiliary Lifting Point, located under the stick.



Stick height	Axe lock	Lift point	3000			4500			6000			7500			mm			
			ALP	ALP	ALP	ALP	ALP	ALP	ALP	ALP	ALP	ALP	ALP	ALP	ALP	ALP	ALP	
7500	TOOLPOINT					6800*	6800*	5500							5450*	5450*	4500	5050
	ALP														6900*	6900*	5700	4300
6000	TOOLPOINT					6750*	6750*	6050*	5500*	4100	3500				4500*	3650	3100	6410
	ALP														5650*	4150	3500	5850
4500	TOOLPOINT	9950*	9950*	9750*	7300*	6200	5450	5400*	4100	4150*					4200*	3000	2550	7180
	ALP	10300*	10300*	9600*	7650*	6000	5350	5650*	4000	3400					4300	3300	2800	6700
3000	TOOLPOINT	10000*	10000*	9400*	8400*	5750	5300	5850*	3950	3550	3600	2800	2350	4100*	2750	2300	7560	
	ALP				8250*	5750	5800*	5850*	3950	3350					3850	2950	2500	7110
1500	TOOLPOINT	12000*	12000*	9000*	7900*	5800	5950*	5000	3800	3450	3550	2750	2300	3500	2700	2250	7620	
	ALP				8250*	5750	5150	5000	3850	3300					3750	2900	2400	7160
0	TOOLPOINT	14050*	10500	8950	7350	5400	5050	4900	3750	3300					3650	2800	2350	7350
	ALP				7600	5650	5000	4850	3700	3150					3950	3000	2500	6880
-1500	TOOLPOINT	14500*	10350	8850	7650	5650	4950	4900	3700	3150								6470
	ALP				7500	5600	4800											5860
-3000	TOOLPOINT			8900														
	ALP																	

### ROAD MODE – COUNTERWEIGHT: 7.4 T

All values are in kg. ALP stands for Auxiliary Lifting Point, located under the stick.

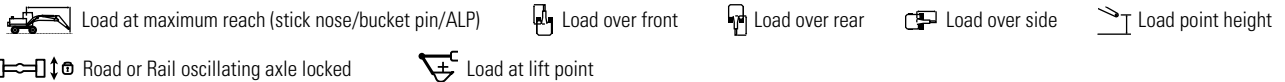

Stick height	Axe lock	Lift point	3000			4500			6000			7500			mm			
			ALP	ALP	ALP	ALP	ALP	ALP	ALP	ALP	ALP	ALP	ALP	ALP	ALP	ALP		
7500	TOOLPOINT					6800*	6800*	5950							5450*	5450*	5450*	5050
	ALP														6900*	6900*	6900*	4300
6000	TOOLPOINT					6750*	6750*	6050*	5500*	4450	3800				4500*	4500*	3400	6410
	ALP														5650*	4500	3850	5850
4500	TOOLPOINT	9950*	9950*	9750*	7300*	7300*	5950*	5400*	4450	4150*					4200*	3300	2800	7180
	ALP	10300*	10300*	9600*	7650*	6500	5850*	5650*	4350	3700					5250*	3600	3100	6700
3000	TOOLPOINT	10000*	10000*	9400*	8400*	6250	5800*	5850*	4300	4150*	4350*	3050	2600	4100*	3000	2550	7560	
	ALP				8250*	6250	5800*	5850*	4300	3650					4200	3250	2750	7110
1500	TOOLPOINT	12000*	12000*	9000*	7900*	6300	5950*	6200*	4200	3750	3900	3000	2550	4250*	2950	2500	7620	
	ALP				8250*	6250	6300*	5400	4150	3650					4100	3150	2700	7160
0	TOOLPOINT	14050*	11400	9750	7950	5900	5500	5300	4050	3600					4000*	3050	2600	7350
	ALP				8200	6100	5450	5300	4050	3500					4300	3300	2800	6880
-1500	TOOLPOINT	14500*	11300	9650	8250	6200	5400	5300	4100	3500								6470
	ALP				8150	6050	5250											5860
-3000	TOOLPOINT			9700														
	ALP																	





\* Limited by hydraulic rather than tipping load. Values are calculated using the stub boom. Under certain front linkage position, it is possible to increase lifting capacities using the variable adjustable boom (fore boom) and the stick cylinders.



Lift capacity ratings are based on ISO 10567:2007, they do not exceed 87% of hydraulic lifting capacity or 75% of tipping load. The oscillating axle must be locked. Lifting capacities are based on the machine standing on a firm uniform supporting surface. Lifting capacities with load over side are calculated with optimized position of the front linkage. Values at the auxiliary lifting point (ALP) with a reach under 4500 mm are calculated with the stick positioned vertically. Values at toolpoint with a reach set at 3000 mm are calculated with the stick folded back towards the machine, additional lowering control valve on stick cylinder head end is required for load lifting.

For lifting capacity including bucket and/or quick coupler, the respective weight has to be subtracted from above values. The use of a work tool attachment point to handle/ lift objects, could affect the machine lift performance.

## RAIL MODE – COUNTERWEIGHT: 6.4 T – UIC & BROAD GAUGE – LEVEL TRACK (CANT: 0 MM)

All values are in kg. ALP stands for Auxiliary Lifting Point, located under the stick.





 Load at maximum reach (stick nose/bucket pin/ALP)
  Load over front
  Load over rear
  Load over side
  Load point height



 Road or Rail oscillating axle locked
  Load at lift point

Reach (mm)	Toolpoint / ALP	3000			4500			6000			7500			mm			
		ALP	ALP	ALP	ALP	ALP	ALP	ALP	ALP	ALP	ALP	ALP					
7500	TOOLPOINT				6800*		4050							5450*	3300	5050	
	ALP													6900*	4150	4300	
6000	TOOLPOINT				6750*		4100	5500*	2550					4500*	2250	6410	
	ALP													5650*	2550	5850	
4500	TOOLPOINT	9950*	6900		7300*	4000	5400*	2600							4200*	1800	7180
	ALP	10300*	6800		7650*	3900	5650*	2450							5250*	2000	6700
3000	TOOLPOINT	10000*	6600		8400*	3900	5850*	2600	4350*	1650					4100*	1600	7560
	ALP				8250*	3850	5850*	2400							5200*	1750	7110
1500	TOOLPOINT	12000*	6500		7900*	3850	6200*	2500	4700*	1600					4250*	1550	7620
	ALP				8250*	3750	6250*	2350							4800*	1650	7160
0	TOOLPOINT	14050*	6150		8700*	3600	6350*	2350							4000*	1600	7350
	ALP				8900*	3550	6250*	2250							4250*	1750	6880
-1500	TOOLPOINT	14500*	6050		9000*	3500	5500*	2250							4200*	2000	6470
	ALP				8400*	3400									4700*	2250	5860
-3000	TOOLPOINT		6100														
	ALP																

## RAIL MODE – COUNTERWEIGHT: 7.4 T – UIC & BROAD GAUGE – LEVEL TRACK (CANT: 0 MM)

All values are in kg. ALP stands for Auxiliary Lifting Point, located under the stick.

 Load at maximum reach (stick nose/bucket pin/ALP)
  Load over front
  Load over rear
  Load over side
  Load point height

 Road or Rail oscillating axle locked
  Load at lift point

Reach (mm)	Toolpoint / ALP	3000			4500			6000			7500			mm			
		ALP	ALP	ALP	ALP	ALP	ALP	ALP	ALP	ALP	ALP						
7500	TOOLPOINT				6800*		4450							5450*	3650	5050	
	ALP													6900*	4550	4300	
6000	TOOLPOINT				6750*		4500	5500*	2850					4500*	2500	6410	
	ALP													5650*	2800	5850	
4500	TOOLPOINT	9950*	7550		7300*	4400	5400*	2900							4200*	2050	7180
	ALP	10300*	7400		7650*	4300	5650*	2750							5250*	2250	6700
3000	TOOLPOINT	10000*	7250		8400*	4250	5850*	2850	4350*	1900					4100*	1850	7560
	ALP				8250*	4250	5850*	2700							5200*	2000	7110
1500	TOOLPOINT	12000*	7200		7900*	4200	6200*	2800	4700*	1850					4250*	1800	7620
	ALP				8250*	4150	6250*	2650							4800*	1900	7160
0	TOOLPOINT	14050*	6800		8700*	4000	6350*	2650							4000*	1850	7350
	ALP				8900*	3950	6250*	2500							4250*	2000	6880
-1500	TOOLPOINT	14500*	6700		9000*	3900	5500*	2500							4200*	2250	6470
	ALP				8400*	3800									4700*	2500	5860
-3000	TOOLPOINT		6750														
	ALP																





\* Limited by hydraulic rather than tipping load. Values are calculated using the stub boom. Under certain front linkage position, it is possible to increase lifting capacities using the variable adjustable boom (fore boom) and the stick cylinders.

Lift capacity ratings are based on ISO 10567:2007, they do not exceed 87% of hydraulic lifting capacity or 75% of tipping load. The oscillating axle must be locked. Lifting capacities are based on the machine standing on a firm uniform supporting surface. Lifting capacities with load over side are calculated with optimized position of the front linkage. Values at the auxiliary lifting point (ALP) with a reach under 4500 mm are calculated with the stick positioned vertically. Values at toolpoint with a reach set at 3000 mm are calculated with the stick folded back towards the machine, additional lowering control valve on stick cylinder head end is required for load lifting.

For lifting capacity including bucket and/or quick coupler, the respective weight has to be subtracted from above values. The use of a work tool attachment point to handle/ lift objects, could affect the machine lift performance.

## RAIL MODE – COUNTERWEIGHT: 6.4 T – UIC & BROAD GAUGE – TRACK CANT: 200 MM















All values are in kg. ALP stands for Auxiliary Lifting Point, located under the stick.

 Load at maximum reach (stick nose/bucket pin/ALP)  Load over front  Load over rear  Load over side  Load point height

 Road or Rail oscillating axle locked





 Load at lift point

 Load point height is related to the plane passing through the rails

		3000			4500			6000			7500				mm			
																		
7500	TOOLPOINT				6800*		2600							5450*	2100	5050		
	ALP													6900*	2100	4300		
6000	TOOLPOINT				6750*		2700	5500*	1600							4500*	1350	6410
	ALP															5650*	1350	5850
4500	TOOLPOINT	9950*	4550		7300*	2600	5400*	1650							4200*	1050	7180	
	ALP	10300*	3550		7650*	2250	5650*	1350							5250*	1050	6700	
3000	TOOLPOINT	10000*	4350		8400*	2550	5850*	1650	4350*	950				4100*	950	7560		
	ALP				8250*	2300	5850*	1400						5200*	950	7110		
1500	TOOLPOINT	12000*	4400		7900*	2550	6200*	1600	4700*	950				4250*	950	7620		
	ALP				8250*	2350	6250*	1450						4800*	950	7160		
0	TOOLPOINT	14050*	4100		8700*	2400	6350*	1500							4000*	1000	7350	
	ALP				8900*	2400	6250*	1400						4250*	1100	6880		
-1500	TOOLPOINT	14500*	4100		9000*	2350	5500*	1450							4200*	1250	6470	
	ALP				8400*	2400								4700*	1500	5860		
-3000	TOOLPOINT		4250															
	ALP																	

## RAIL MODE – COUNTERWEIGHT: 7.4 T – UIC & BROAD GAUGE – TRACK CANT: 200 MM















All values are in kg. ALP stands for Auxiliary Lifting Point, located under the stick.

 Load at maximum reach (stick nose/bucket pin/ALP)  Load over front  Load over rear  Load over side  Load point height

 Road or Rail oscillating axle locked

 Load at lift point

 Load point height is related to the plane passing through the rails

		3000			4500			6000			7500				mm			
																		
7500	TOOLPOINT				6800*		2900							5450*	2350	5050		
	ALP															6900*	2350	4300
6000	TOOLPOINT				6750*		3000	5500*	1800							4500*	1550	6410
	ALP															5650*	1550	5850
4500	TOOLPOINT	9950*	5050		7300*	2900	5400*	1900							4200*	1250	7180	
	ALP	10300*	3950		7650*	2500	5650*	1550							5250*	1250	6700	
3000	TOOLPOINT	10000*	4850		8400*	2850	5850*	1900	4350*	1150				4100*	1100	7560		
	ALP				8250*	2550	5850*	1600						5200*	1150	7110		
1500	TOOLPOINT	12000*	4850		7900*	2850	6200*	1850	4700*	1150				4250*	1100	7620		
	ALP				8250*	2650	6250*	1650						4800*	1150	7160		
0	TOOLPOINT	14050*	4600		8700*	2700	6350*	1700							4000*	1150	7350	
	ALP				8900*	2650	6250*	1650						4250*	1250	6880		
-1500	TOOLPOINT	14500*	4600		9000*	2650	5500*	1650							4200*	1450	6470	
	ALP				8400*	2750								4700*	1750	5860		
-3000	TOOLPOINT		4750															
	ALP																	

\* Limited by hydraulic rather than tipping load. Values are calculated using the stub boom. Under certain front linkage position, it is possible to increase lifting capacities using the variable adjustable boom (fore boom) and the stick cylinders.





Lift capacity ratings are based on ISO 10567:2007, they do not exceed 87% of hydraulic lifting capacity or 75% of tipping load. The oscillating axle must be locked. Lifting capacities are based on the machine standing on a firm uniform supporting surface. Lifting capacities with load over side are calculated with optimized position of the front linkage. Values at the auxiliary lifting point (ALP) with a reach under 4500 mm are calculated with the stick positioned vertically. Values at toolpoint with a reach set at 3000 mm are calculated with the stick folded back towards the machine, additional lowering control valve on stick cylinder head end is required for load lifting.



For lifting capacity including bucket and/or quick coupler, the respective weight has to be subtracted from above values. The use of a work tool attachment point to handle/ lift objects, could affect the machine lift performance.



## RAIL MODE – COUNTERWEIGHT: 6.4 T – METRIC TRACK – LEVEL TRACK (CANT 0 MM)

All values are in kg. ALP stands for Auxiliary Lifting Point, located under the stick.





 Load at maximum reach (stick nose/bucket pin/ALP)
  Load over front
  Load over rear
  Load over side
  Load point height



 Road or Rail oscillating axle locked
  Load at lift point

Reach (mm)	Toolpoint / ALP	3000			4500			6000			7500			mm		
		ALP	ALP	ALP	ALP	ALP	ALP	ALP	ALP	ALP	ALP	ALP				
7500	TOOLPOINT				6800*		2950							5450*	2350	5050
	ALP													6900*	3000	4300
6000	TOOLPOINT				6750*		3000	5500*		1800				4500*	1550	6410
	ALP													5650*	1800	5850
4500	TOOLPOINT	9950*	4900		7300*	2900		5400*	1900					4200*	1250	7180
	ALP	10300*	4800		7650*	2850		5650*	1750					5250*	1350	6700
3000	TOOLPOINT	10000*	4600		8400*	2800		5850*	1850	4350*	1100			4100*	1100	7560
	ALP				8250*	2750		5850*	1700					5200*	1150	7110
1500	TOOLPOINT	12000*	4550		7900*	2750		6200*	1800	4700*	1050			4250*	1050	7620
	ALP				8250*	2650		6250*	1650					4800*	1100	7160
0	TOOLPOINT	14050*	4200		8700*	2550		6350*	1650					4000*	1050	7350
	ALP				8900*	2500		6250*	1500					4250*	1150	6880
-1500	TOOLPOINT	14500*	4100		9000*	2450		5500*	1500					4200*	1300	6470
	ALP				8400*	2350								4700*	1500	5860
-3000	TOOLPOINT		4150													
	ALP															

## RAIL MODE – COUNTERWEIGHT: 7.4 T – METRIC TRACK – LEVEL TRACK (CANT 0 MM)

All values are in kg. ALP stands for Auxiliary Lifting Point, located under the stick.

 Load at maximum reach (stick nose/bucket pin/ALP)
  Load over front
  Load over rear
  Load over side
  Load point height

 Road or Rail oscillating axle locked
  Load at lift point

Reach (mm)	Toolpoint / ALP	3000			4500			6000			7500			mm		
		ALP	ALP	ALP	ALP	ALP	ALP	ALP	ALP	ALP	ALP					
7500	TOOLPOINT				6800*		3300							5450*	2650	5050
	ALP													6900*	3350	4300
6000	TOOLPOINT				6750*		3350	5500*		2050				4500*	1800	6410
	ALP													5650*	2050	5850
4500	TOOLPOINT	9950*	5450		7300*	3200		5400*	2100					4200*	1450	7180
	ALP	10300*	5300		7650*	3150		5650*	1950					5250*	1550	6700
3000	TOOLPOINT	10000*	5150		8400*	3150		5850*	2100	4350*	1300			4100*	1250	7560
	ALP				8250*	3100		5850*	1900					5200*	1350	7110
1500	TOOLPOINT	12000*	5100		7900*	3050		6200*	2000	4700*	1250			4250*	1200	7620
	ALP				8250*	3000		6250*	1900					4800*	1300	7160
0	TOOLPOINT	14050*	4700		8700*	2850		6350*	1900					4000*	1250	7350
	ALP				8900*	2850		6250*	1750					4250*	1350	6880
-1500	TOOLPOINT	14500*	4650		9000*	2800		5500*	1750					4200*	1550	6470
	ALP				8400*	2650								4700*	1750	5860
-3000	TOOLPOINT		4700													
	ALP															

\* Limited by hydraulic rather than tipping load. Values are calculated using the stub boom. Under certain front linkage position, it is possible to increase lifting capacities using the variable adjustable boom (fore boom) and the stick cylinders.

Lift capacity ratings are based on ISO 10567:2007, they do not exceed 87% of hydraulic lifting capacity or 75% of tipping load. The oscillating axle must be locked. Lifting capacities are based on the machine standing on a firm uniform supporting surface. Lifting capacities with load over side are calculated with optimized position of the front linkage. Values at the auxiliary lifting point (ALP) with a reach under 4500 mm are calculated with the stick positioned vertically. Values at toolpoint with a reach set at 3000 mm are calculated with the stick folded back towards the machine, additional lowering control valve on stick cylinder head end is required for load lifting.

For lifting capacity including bucket and/or quick coupler, the respective weight has to be subtracted from above values. The use of a work tool attachment point to handle/ lift objects, could affect the machine lift performance.

## RAIL MODE – COUNTERWEIGHT: 6.4 T – METRIC TRACK – TRACK CANT: 105 MM

All values are in kg. ALP stands for Auxiliary Lifting Point, located under the stick.

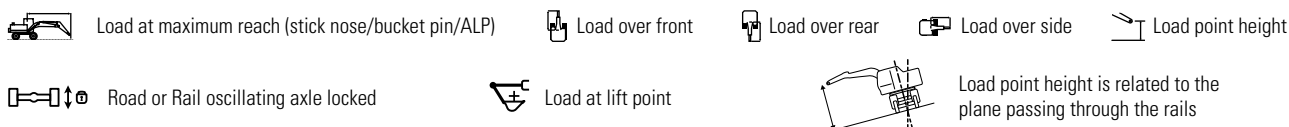

Reach (mm)	Oscillating axle locked	Lift point	3000			4500			6000			7500			mm	
			Front	Rear	Side	Front	Rear	Side	Front	Rear	Side	Front	Rear	Side		
7500	TOOLPOINT					6800*		1700						5450*	1350	5050
	ALP													6900*	1700	4300
6000	TOOLPOINT					6750*		1800	5500*		1050			4500*	900	6410
	ALP													5650*	1000	5850
4500	TOOLPOINT		9950*	2900		7300*	1800		5400*		1150			4200*	700	7180
	ALP		10300*	2800		7650*	1750		5650*		1000			5250*	750	6700
3000	TOOLPOINT		10000*	2850		8400*	1800		5850*	1200		4350*	600	4100*	600	7560
	ALP					8250*	1750		5850*	1000				5200*	650	7110
1500	TOOLPOINT		12000*	3000		7900*	1850		6200*	1150		4700*	600	4250*	600	7620
	ALP					8250*	1750		6250*	1050				4800*	600	7160
0	TOOLPOINT		14050*	2900		8700*	1750		6350*	1050				4000*	650	7350
	ALP					8900*	1700		6250*	950				4250*	700	6880
-1500	TOOLPOINT		14500*	3050		9000*	1750		5500*	1000				4200*	850	6470
	ALP					8400*	1650							4700*	1000	5860
-3000	TOOLPOINT			3450												
	ALP															

## RAIL MODE – COUNTERWEIGHT: 7.4 T – METRIC TRACK – TRACK CANT: 105 MM

All values are in kg. ALP stands for Auxiliary Lifting Point, located under the stick.

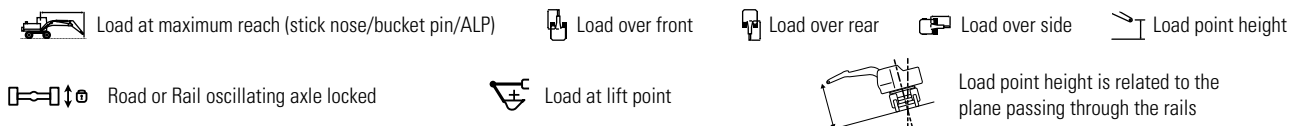

Reach (mm)	Oscillating axle locked	Lift point	3000			4500			6000			7500			mm	
			Front	Rear	Side	Front	Rear	Side	Front	Rear	Side	Front	Rear	Side		
7500	TOOLPOINT					6800*		1900						5450*	1550	5050
	ALP													6900*	1900	4300
6000	TOOLPOINT					6750*		2050	5500*		1250			4500*	1050	6410
	ALP													5650*	1200	5850
4500	TOOLPOINT		9950*	3250		7300*	2050		5400*		1300			4200*	850	7180
	ALP		10300*	3200		7650*	2000		5650*		1200			5250*	900	6700
3000	TOOLPOINT		10000*	3250		8400*	2050		5850*	1350		4350*	750	4100*	750	7560
	ALP					8250*	2000		5850*	1200				5200*	800	7110
1500	TOOLPOINT		12000*	3450		7900*	2100		6200*	1350		4700*	750	4250*	750	7620
	ALP					8250*	2050		6250*	1200				4800*	800	7160
0	TOOLPOINT		14050*	3350		8700*	2000		6350*	1250				4000*	800	7350
	ALP					8900*	1950		6250*	1150				4250*	850	6880
-1500	TOOLPOINT		14500*	3500		9000*	2050		5500*	1200				4200*	1050	6470
	ALP					8400*	1950							4700*	1200	5860
-3000	TOOLPOINT			3900												
	ALP															

\* Limited by hydraulic rather than tipping load. Values are calculated using the stub boom. Under certain front linkage position, it is possible to increase lifting capacities using the variable adjustable boom (fore boom) and the stick cylinders.

Lift capacity ratings are based on ISO 10567:2007, they do not exceed 87% of hydraulic lifting capacity or 75% of tipping load. The oscillating axle must be locked. Lifting capacities are based on the machine standing on a firm uniform supporting surface. Lifting capacities with load over side are calculated with optimized position of the front linkage. Values at the auxiliary lifting point (ALP) with a reach under 4500 mm are calculated with the stick positioned vertically. Values at toolpoint with a reach set at 3000 mm are calculated with the stick folded back towards the machine, additional lowering control valve on stick cylinder head end is required for load lifting.

For lifting capacity including bucket and/or quick coupler, the respective weight has to be subtracted from above values. The use of a work tool attachment point to handle/ lift objects, could affect the machine lift performance.

INCREASE YOUR PRODUCTIVITY AND PROFIT

# WITH CAT ATTACHMENTS

You can easily expand the performance of your machine by utilizing any of the variety of Cat Attachments. Each Cat Attachment is designed to fit the weight and horsepower of Cat Excavators for improved performance, safety and stability.



THE M323F IS A VERY VERSATILE MACHINE... BUT ONLY AS VERSATILE AS THE TOOLS BEING USED ON THE MACHINE

- Wide range of couplers, buckets and hydraulic work tools, commonly used on all wheeled excavator machines
- For a wide range of on-road and off-road wheeled excavator applications
- For on-rail jobs which do not require dedicated rail work tools

KINSHOFER AS PREFERRED SUPPLIER

- Best in class for RailRoad Work Tools
- High quality / durability
- Complete offering
- Tools certified for EU countries

CAT OFFERS A FULL RANGE OF WORK TOOLS FOR ALL APPLICATIONS

- Standard Cat Work Tools portfolio for couplers, buckets and hydraulic tools
- Alliance partner Rototilt in Sweden for Tilt-Rotators
- Alliance partner Kinshofer in Germany for Dedicated Rail/Road Tools

FULL RANGE OF DEDICATED TOOLS FOR APPLICATIONS

- Railway construction
- Railway maintenance
- Railway removal
- Support and transport jobs

# STANDARD TOOLS

## STANDARD WHEELED EXCAVATOR WORK TOOLS PORTFOLIO

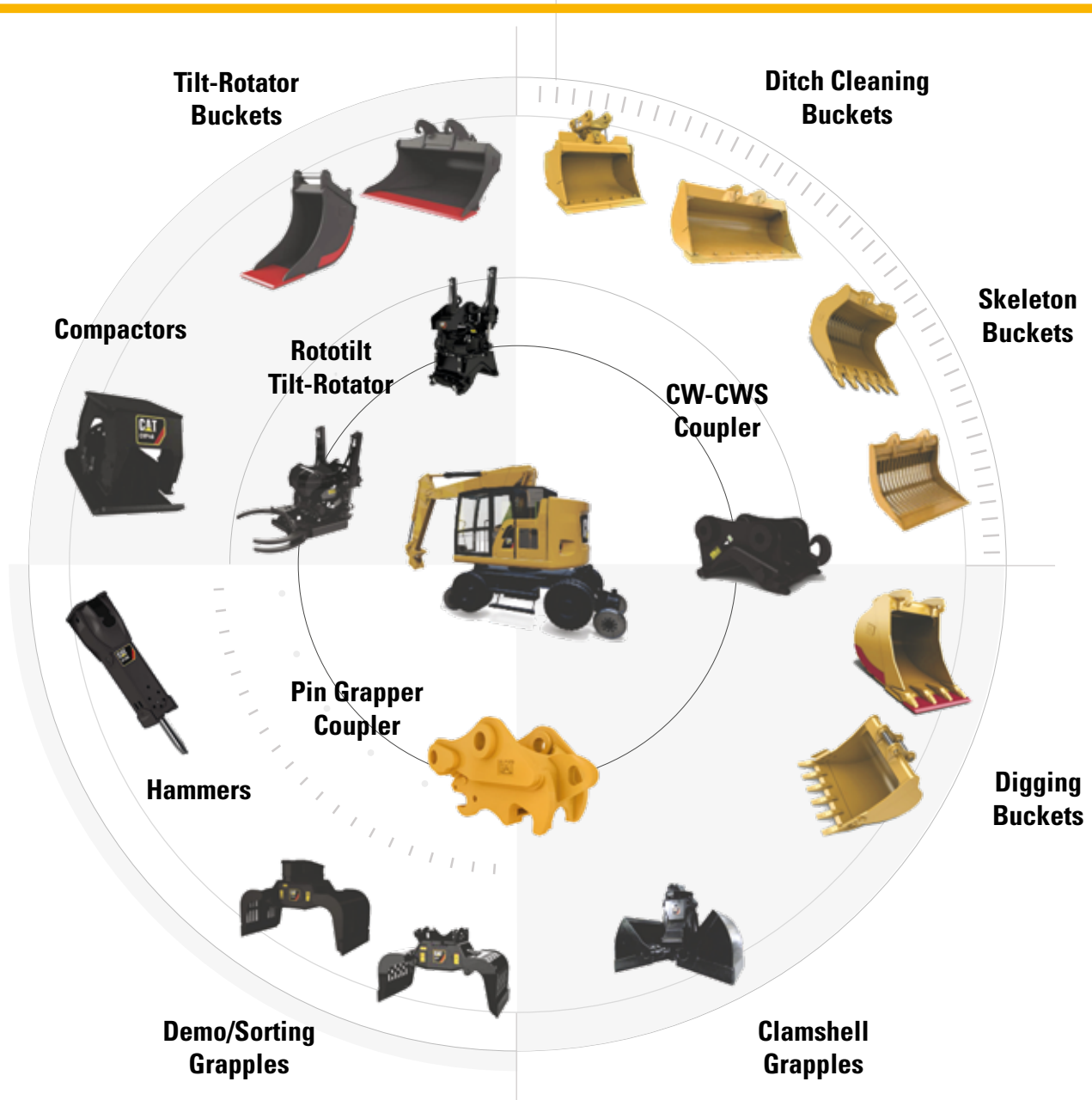

# DEDICATED TOOLS

SPECIALTY TOOLS FOR RAIL APPLICATIONS

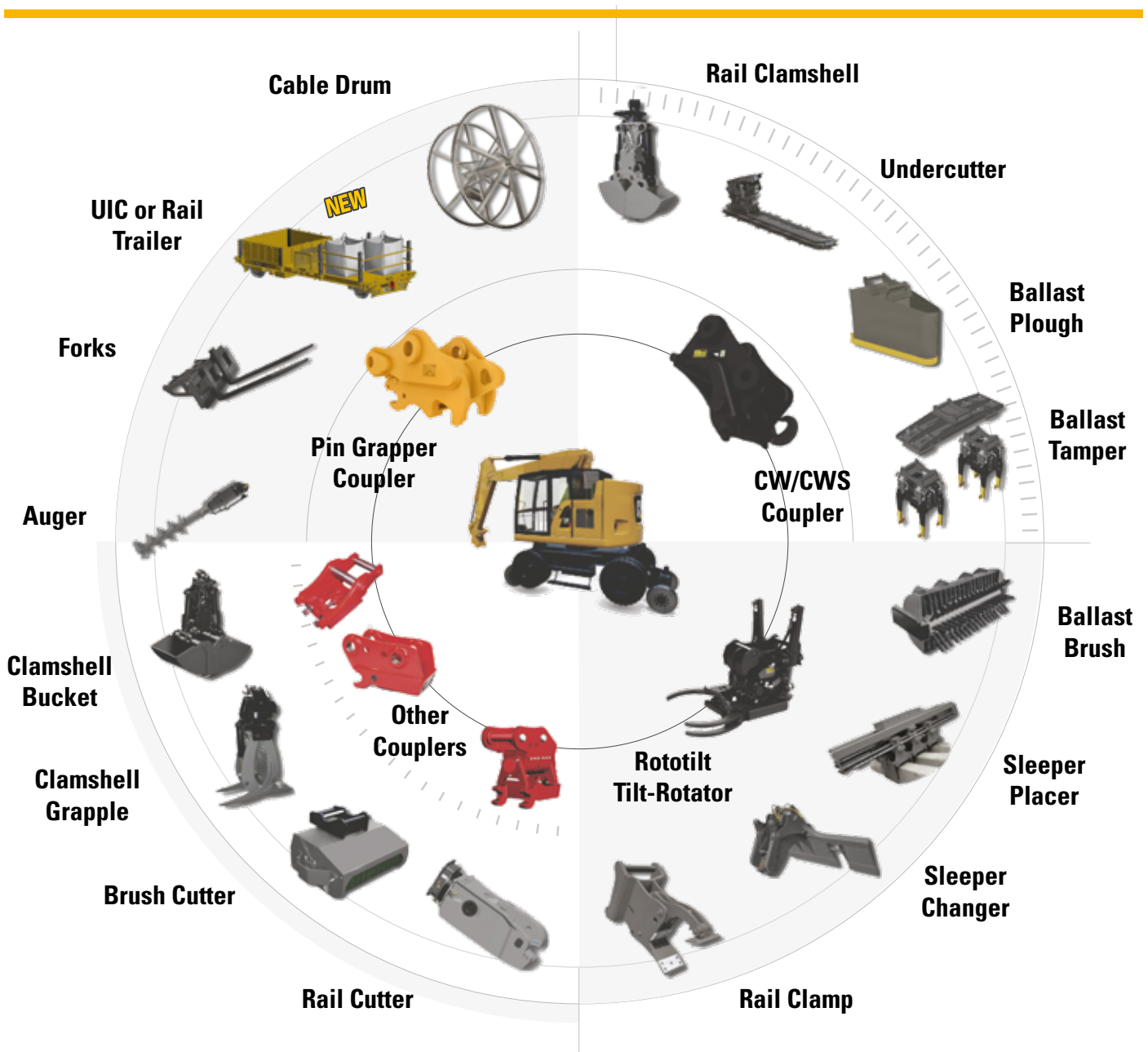

# TECHNICAL SPECIFICATIONS

See [cat.com](http://cat.com) for complete specifications.

ENGINE		
Engine Model	Cat C4.4 ACERT™	
Ratings	1900 rpm*	
Rated Net Power (ISO 9249/SAE J1349)	127 kW	170 hp
Maximum Net Power (ISO 9249/SAE J1349)	129 kW	173 hp
Maximum Gross Power (ISO 14396)	129 kW	173 hp
Bore	105 mm	4 in
Stroke	127 mm	5 in
Displacement	4.4 L	269 in <sup>3</sup>
Maximum Torque at 1,400 rpm	750 N.m	524 lb-ft
Number of Cylinders - In Line	4	
<ul style="list-style-type: none"> <li>Meets Stage V Emission Standards</li> <li>Net power advertised is the power available at the flywheel when engine is equipped with air cleaner, CEM exhaust gas aftertreatment, alternator, and cooling fan running at intermediate speed</li> <li>No deratings required up to 3,000 m (9,842 ft) altitude. Automatic derating occurs after 3,000 m (9,842 ft).</li> </ul>		
* : Augmented hydraulic flow at main pump output between 1900 rpm and 2200 rpm.		
SWING MECHANISM		
Maximum Swing Speed	11 rpm	
Maximum Swing Torque	42 kN.m	30,978 lbf-ft
WEIGHTS		
Operating Weights*	22900 kg - 23900 kg	50,486 lb - 52,690 lb
Sticks		
2000 mm	600 kg	1,323 lb
Counterweights		
Standard	6400 kg	14,110 lb
Optional	7400 kg	16,314 lb
* : Operating weight includes short stick, 6400 kg counterweight, full fuel tank, operator, no quick coupler, no bucket and dual pneumatic tires. Weight varies based on configuration.		
TIRES		
Standard, MITAS NB38	10.00 - 20 (Dual)	
Optional, Michelin XF	445/70 R19.5 TL (Single)	
DRIVE		
Maximum Gradeability (22 900 kg/50,486 lb)	53%	
Maximum Travel Speed - Road or Rail	20 km/h	12.4 mph
Drawbar Pull - Road Mode	104 kN	23,380 lbf
Drawbar Pull - Rail Mode	45 kN	10,116 lbf
HYDRAULIC SYSTEM		
Tank Capacity	122 L	32 gal
System	240 L	63 gal
Maximum Pressure - Implement Circuit		
Normal	35,000 kPa	5,076 psi
Heavy Lift	37,500 kPa	5,439 psi
Travel Circuit	35,000 kPa	5,076 psi
Maximum Pressure - Auxiliary Circuit		
High Pressure	35,000 kPa	5,076 psi
Medium Pressure	18,500 kPa	2,683 psi
Swing Mechanism	37,000 kPa	5,366 psi
Maximum Flow		
Implement/Travel Circuit	260 L/min	69 gal/min
Auxiliary Circuit		
High Pressure	260 L/min	69 gal/min
Medium Pressure	70 L/min	18 gal/min
Swing Mechanism	90 L/min	24 gal/min

SERVICE REFILL CAPACITIES		
Fuel Tank Capacity	240 L	63.4 gal
Cooling System	30 L	7.9 gal
Engine Crankcase	13 L	3.4 gal
Rear Axle Housing (differential)	11.2 L	3.0 gal
Front Steering Axle (differential)	9 L	2.4 gal
Final Drive	2.4 L	0.6 gal
Powershift Transmission	2.5 L	0.7 gal
DEF Tank	19 L	5.0 gal
STANDARDS		
Cab/ROPS	ISO 12117-2:2008	
RAIL POWER TRAIN		
Rail Wheel (UIC profile)	Ø632 mm	Ø21"
Rail Track Gauge (UIC)	1435 mm	4'8.5"
Rail Wheel (Metric profile)	Ø638 mm	
Rail Track Gauge (Metric)	1000 mm	3'3.4"
Rail Wheel (Broad Gauge profile)	Ø632 mm	Ø21"
Rail Track Gauge (Broad Gauge)	1600 mm	5'3.0"
Park Brake (integrated in motor)	Multi-disc	
Tire Ground Clearance on Rail (with single tire)	184 mm	0'7"
UNDERCARRIAGE		
Road Ground Clearance	370 mm	1'3"
Rail Ground Clearance	184 mm	0'7"
Maximum Steering Angle	35°	
Oscillation Axle Angle	±8.5°	
Minimum Turning Radius:		
Outside of Tire	6300 mm	20'8"
End of VA Boom	7100 mm	23'4"
EMISSIONS AND SAFETY		
Engine Emissions	Stage V	
Fluids (optional)		
Hydraulic Oil - Panolin HLP SYNTH	Readily biodegradable EU Flower Eco-label certified	
Biodiesel up to B20	Meets EN 14214 or ASTM D6751 with EN590 or ASTM D975 Standard Mineral diesel fuels	
Diesel Exhaust Fluid	Must meet ISO 22241	
Vibration Levels		
Maximum Hand/Arm (ISO 5349:2001)	<2.5 m/s <sup>2</sup>	<8.2 ft/s <sup>2</sup>
Maximum Whole Body (ISO/TR 25398:2006)	<0.5 m/s <sup>2</sup>	<1.6 ft/s <sup>2</sup>
Seat Transmissibility Factor (ISO 7096:2000, spectral class EM5)	<0.7 m/s <sup>2</sup>	<2.3 ft/s <sup>2</sup>
SOUND PERFORMANCE		
Operator Sound		
2000/14/EC, ISO 6396:2008	71 dB(A)	
Spectator Sound		
2000/14/EC, ISO 6395:2008	103 dB(A)*	
*Noise level is for a machine without the generator.		
<ul style="list-style-type: none"> <li>The operator sound level is measured according to the procedures specified in 2000/14/EC and ISO 6396:2008, for a cab offered by Caterpillar, when properly installed, maintained, and tested with the door and windows closed.</li> <li>The external sound level is measured according to the test procedures and conditions specified in 2000/14/EC as amended by 2005/88/EC.</li> <li>Hearing protection may be needed when operating with an open operator station and cab (when not properly maintained or doors/windows open) for extended periods or in a noisy environment.</li> </ul>		

# STANDARD & OPTIONAL EQUIPMENT

Standard and optional equipment may vary. Consult your Cat dealer for details.

UNDERCARRIAGE AND STRUCTURES	STANDARD	OPTIONAL
Heavy-duty road and rail axles with advanced disc brake system and travel motor with adjustable braking force	•	
Road and rail all-wheel drive	•	
Two-speed hydrostatic transmission (road and rail)	•	
Independent rail hydrostatic drive (1 motor per axle)	•	
Rail wheels (insulated if required by local regulations)	•	
Automatic oscillating rail axle lock	•	
6.4 t (14,110 lb) counterweight	•	
7.4 t (16,314 lb) counterweight		•
Travel restraint bracket for clamshell/grapple		•
Emergency Tow Bar	•	
UIC Tow Bar		•
Trailer coupling (automatic lock type) and trailer plug		•
Left and right-side footboards with retractable step	•	
Lockable box at front top of undercarriage	•	
One or two additional tool boxes at undercarriage steps		•
Roading package (road homologation)		•
HYDRAULIC SYSTEM	STANDARD	OPTIONAL
Adjustable hydraulic sensitivity	•	
One medium pressure circuit	•	
Second medium pressure circuit		•
One high pressure circuit	•	
Second high pressure circuit		•
Dedicated swing pump	•	
Load sensing hydraulic system	•	
Programmable flow and pressure for up to 10 attachments	•	
Auxiliary circuit pedal		•
Biodegradable hydraulic oil		•
Micro-filtration unit (coming standard with bio oil)		•
Engine Power mode (P) – Augmented hydraulic flow	•	
Heavy lift mode	•	
SAFETY AND SECURITY	STANDARD	OPTIONAL
Emergency stop button in operator and second cab	•	
Backup electro-hydraulic pump for rail emergencies	•	
Temporary Limits Off	•	
Manual brake release pump (emergency situation on rail)	•	
Safety stickers for rail certification	•	
Pneumatic system for UIC-type trailer or rail trailer		•
Rear and right-side cameras	•	
ROPS operator and second cab	•	
Rated Capacity Indicator (RCI) and Limiter (RCL) system	•	
Boom lowering control valve (BLCV), fore boom lowering control valve (FLCV) and stick lowering control valve (SLCV), including overload warning device	•	
Bucket lowering control valve		•
Automatic swing brake	•	
Emergency Kit		•
Manual emergency coupling unit (front and rear)	•	
BOOM AND STICKS	STANDARD	OPTIONAL
5.2 m (17'1") VA boom, 2.0 m (6'56") stick	•	

SERVICE & MAINTENANCE	STANDARD	OPTIONAL
Ground-level fuel, engine oil and filters, fluid taps	•	
Centralized lubrication for undercarriage and rail bogies		•
Auto-lubricating system		•
ENGINE	STANDARD	OPTIONAL
Cat C4.4 ACERT™ Stage V Certified Engine	•	
Altitude 3000 m (9,842 ft) capability without de-rate	•	
Electric fuel priming pump	•	
Automatic starting aid	•	
ELECTRICAL SYSTEM	STANDARD	OPTIONAL
Double alternator (115 A)	•	
Main shut-off switch	•	
12 V - 10 A power supply in operator and second cab	•	
Two front and two rear roading lights	•	
Right side, VA boom, and stick working lights		•
Adjustable travel alarm		•
Refueling pump (100 L/min)	•	
24 V - 20 A power socket (e.g. external refueling pump)	•	
International Union of Railways (UIC) certified rail lights		•
Electric & pneumatic signal/warning horn	•	
24 V - 10 A power supply at stick end		•
Jump start terminals	•	
Spare fuses in each fuse box	•	
OPERATOR CAB	STANDARD	OPTIONAL
Hydrostatic deceleration & rail trailer brake control joystick	•	
Instrument panel with signal LEDs and screens for hydrostatic deceleration power & trailer brake pressure	•	
One-way or two-way travel speed pedal	•	
Cruise control system on road and rail	•	
Road/rail mode button and signal	•	
On-/off-tracking guidance through Smart Sytem	•	
12" HD full graphic and color display with tiltable support	•	
Bluetooth (calling) and USB port radio with speakers	•	
Ergonomic pilot operated joysticks	•	
Air conditioner, heater, and defroster	•	
24V Lighter	•	
Bottle holder	•	
Top and bottom mounted, intermittent, parallel wiper and washer for front window and roof window	•	
Washable floor mat with storage compartment	•	
Interior lighting with door switch	•	
Tiltable left side console with lock-out for all controls	•	
Steering lock device	•	
Adjustable steering column	•	
Windshield and skylight sunshade	•	
SECOND CAB	STANDARD	OPTIONAL
Retractable seat belt	•	
Back door and openable roof for maintenance access to top part of the upper frame	•	
Rear window emergency exit	•	
Pneumatic horn control	•	
Support parts for rail safety devices	•	

For more complete information on Cat products, dealer services and industry solutions, visit us on the web at [www.cat.com](http://www.cat.com)

© 2021 Caterpillar. All Rights Reserved.

VisionLink is a trademark of Trimble Navigation Limited, registered in the United States and in other countries.

Materials and specifications are subject to change without notice. Featured machines in photos may include additional equipment. See your Cat dealer for available options.

CAT, CATERPILLAR, their respective logos, "Caterpillar Yellow," the "Power Edge" trade dress as well as corporate and product identity used herein, are trademarks of Caterpillar and may not be used without permission.

[www.cat.com](http://www.cat.com) [www.caterpillar.com](http://www.caterpillar.com)

AEXQ3285

